

Article number: 20804011

Description: E+G Thrust pad
DIN 6311-12-S

Measures

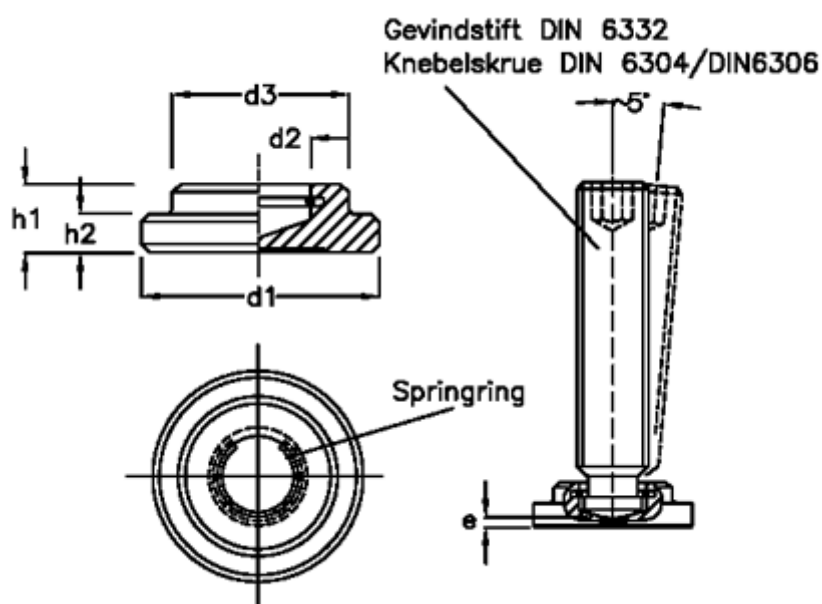

d1 = 12
d2 = 4.6
d3 = 10
e = 2.2
h1 = 7
h2 = 2.5
T = M6